



# STAINLESS STEEL BENT PLATES PART # BP-71

Submit Order

**CONTACT INFO**

Name:

Company:

Phone:

Fax:

Email:

Project Name:

Location:

Notes:

**QUANTITY:**

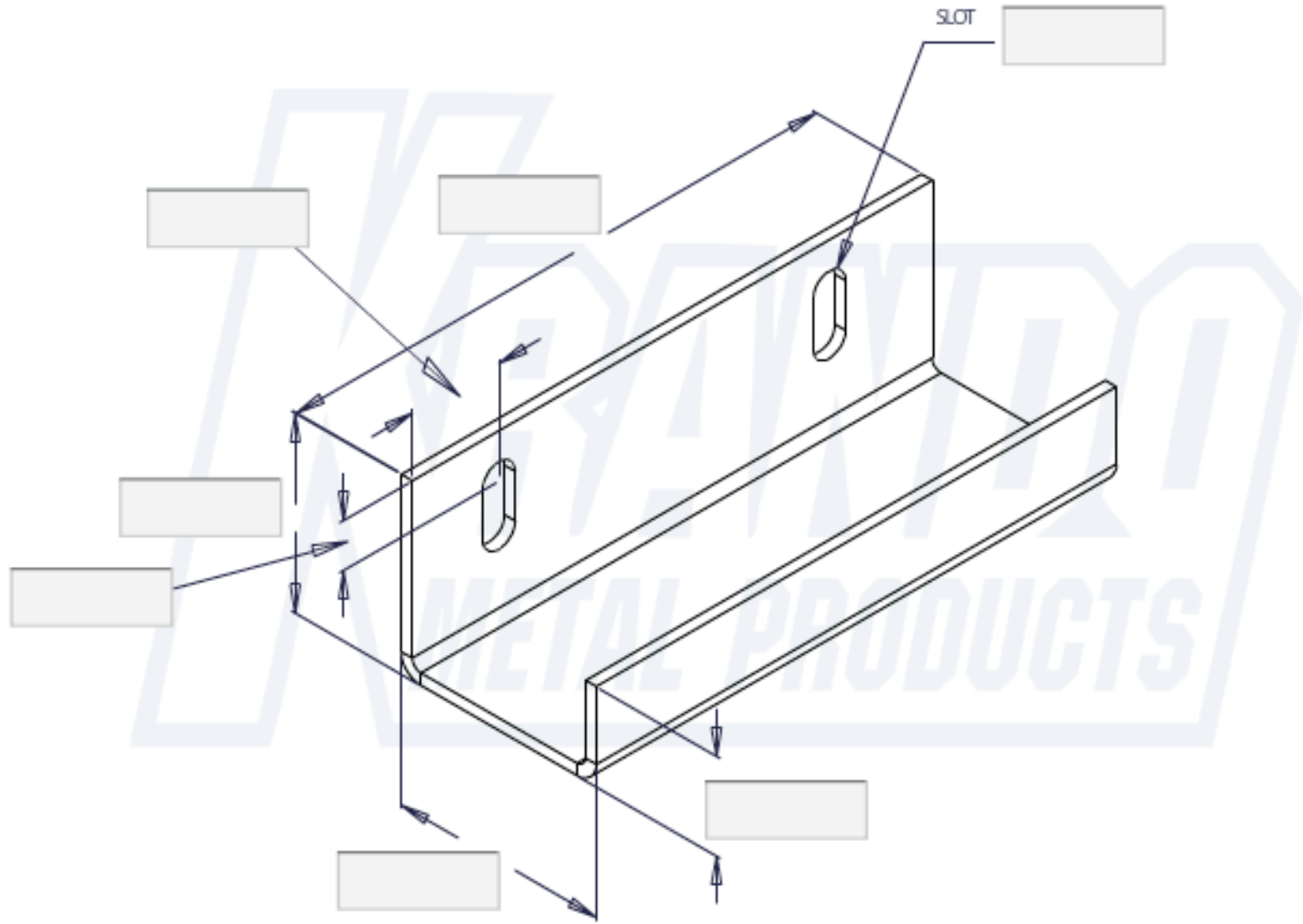

<b>Finish:</b>	<b>Thickness:</b>
<input type="checkbox"/> TYPE 304 STAINLESS STEEL	<input type="checkbox"/> 16 ga. <input type="checkbox"/> 10 ga. <input type="checkbox"/> 3/8"
<input type="checkbox"/> TYPE 316 STAINLESS STEEL	<input type="checkbox"/> 12 ga. <input type="checkbox"/> 3/16'    Other: <input type="text"/>
<input type="checkbox"/> A36 STEEL HOT DIPPED GALVANIZED	<input type="checkbox"/> 1/8" <input type="checkbox"/> 1/4" <input type="text"/>

Krando Metal Products, Inc. reserves the right to determine specific requirements regarding all stone anchors.

**Broomall, PA 610-543-4311**  
**FAX 610-543-3799**



Submit Order