



STAINLESS STEEL DOVE TAILS PART # DT-53

Submit Order

CONTACT INFO

Name:

Company:

Phone:

Fax:

Email:

Project Name:

Location:

Notes:

QUANTITY:

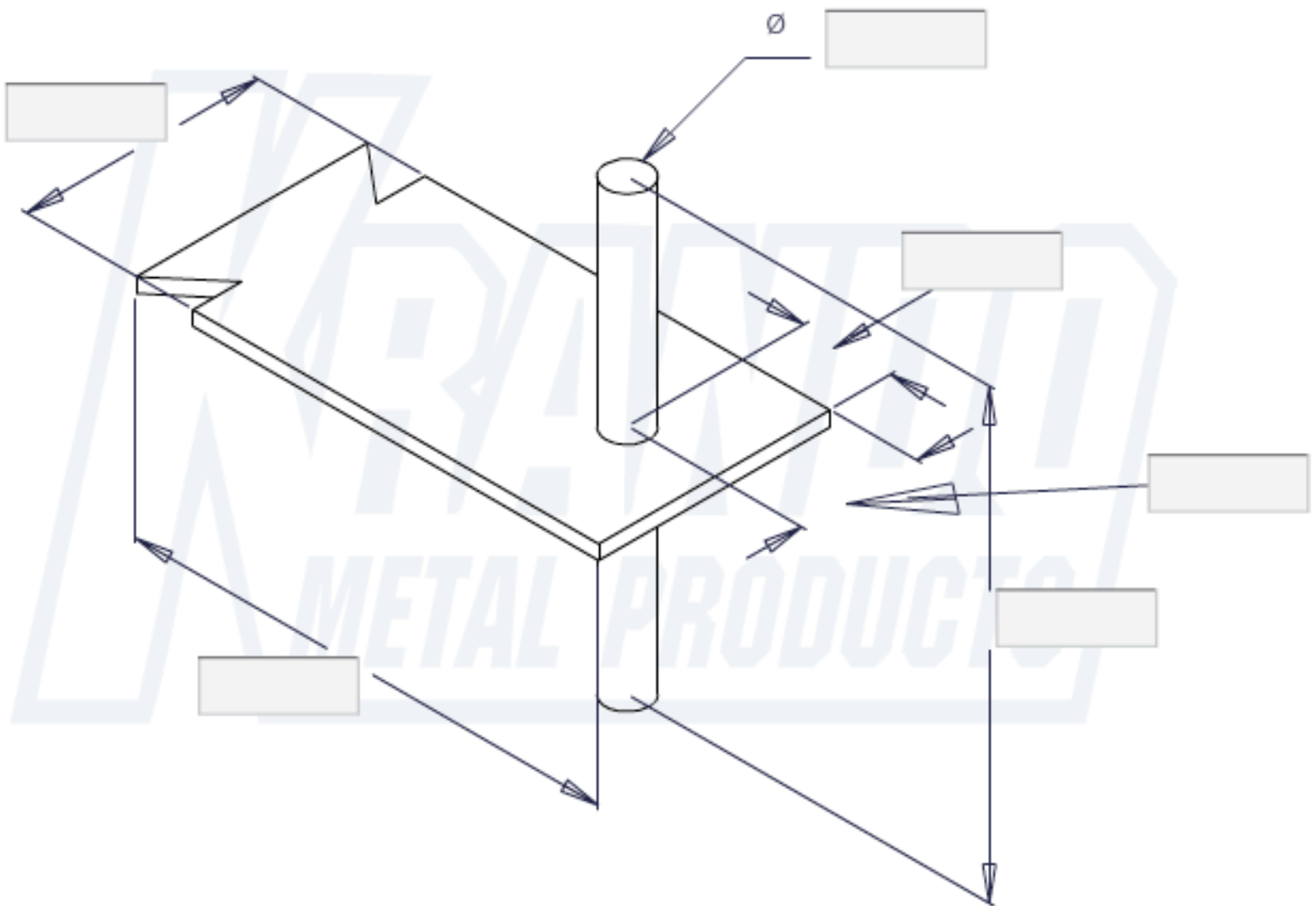

Finish:	Thickness:
<input type="checkbox"/> TYPE 304 STAINLESS STEEL	<input type="checkbox"/> 16 ga. <input type="checkbox"/> 10 ga. <input type="checkbox"/> 3/8"
<input type="checkbox"/> TYPE 316 STAINLESS STEEL	<input type="checkbox"/> 12 ga. <input type="checkbox"/> 3/16' Other: <input type="text"/>
<input type="checkbox"/> A36 STEEL HOT DIPPED GALVANIZED	<input type="checkbox"/> 1/8" <input type="checkbox"/> 1/4" <input type="text"/>

Krando Metal Products, Inc. reserves the right to determine specific requirements regarding all stone anchors.

Broomall, PA 610-543-4311
FAX 610-543-3799



Submit Order